

# **Status of ITU Q13/15 sync standards ITSF-2012**

**Jean-Loup Ferrant,  
ITU-T Q13/15 rapporteur**

# Agenda

**1-Overview of recommendations**

**2-History**

**3-transport of frequency in packet networks**

**4-transport of time and phase in packet networks**

**5-Q13 current work**

**6- ITU-T SG15 recommendations for synchronization**

# 1-Overview of recommendations

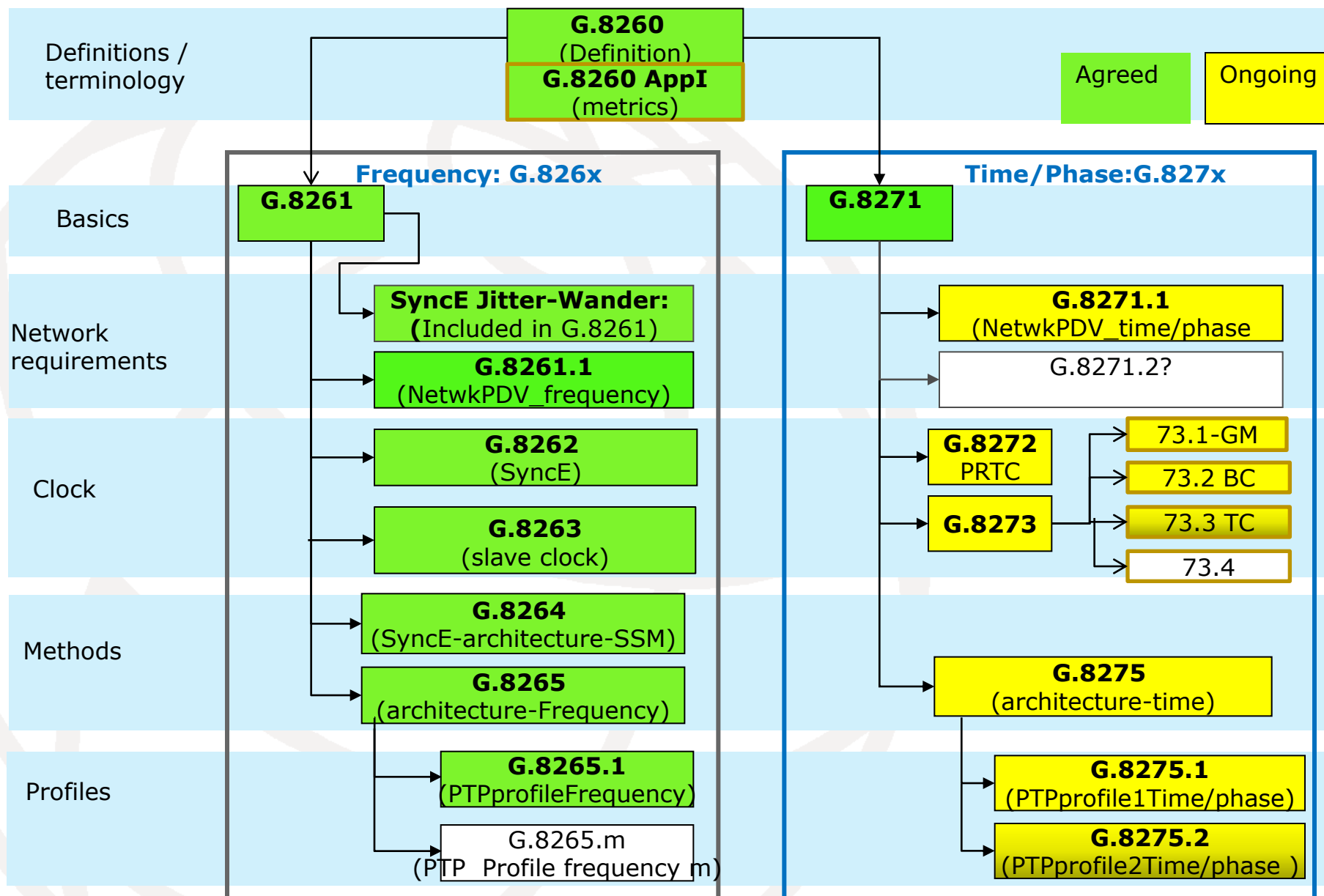

# 2-History

## **1-Overview of recommendations for packet networks**

## **2- Consents in 2010 and february 2011**

2.1 Definitions G.8260

2.2 Frequency transport-SyncE G.8262, G.8264

2.3 Frequency transport G.8261, G.8265, G.8265.1

2.4 OTN G.8251

## **3- Consents in December 2011**

3.1 G.8260- Metric appendix

3.2 G.8261.1 Network limits

3.3 G.8263 packet clock for frequency distribution over packets

3.4 G.8271 Requirements for transport of time over packet networks

3.5 G.8251 Amd2 & corrigendum1 OTN

3.6 G.8262 Amd on SyncE clock

3.6 G.8264 Amd2 & Corr2 SyncE

# 2-History

## **3- Consents in September 2012**

**3.1 G.8272- PRTC**

**3.2 G.8265.1 Amd2**

**3.3 G.8262 Amd2**

**+ G.8251 Amd3 on OTN**

# 3- Transport of frequency in packet networks

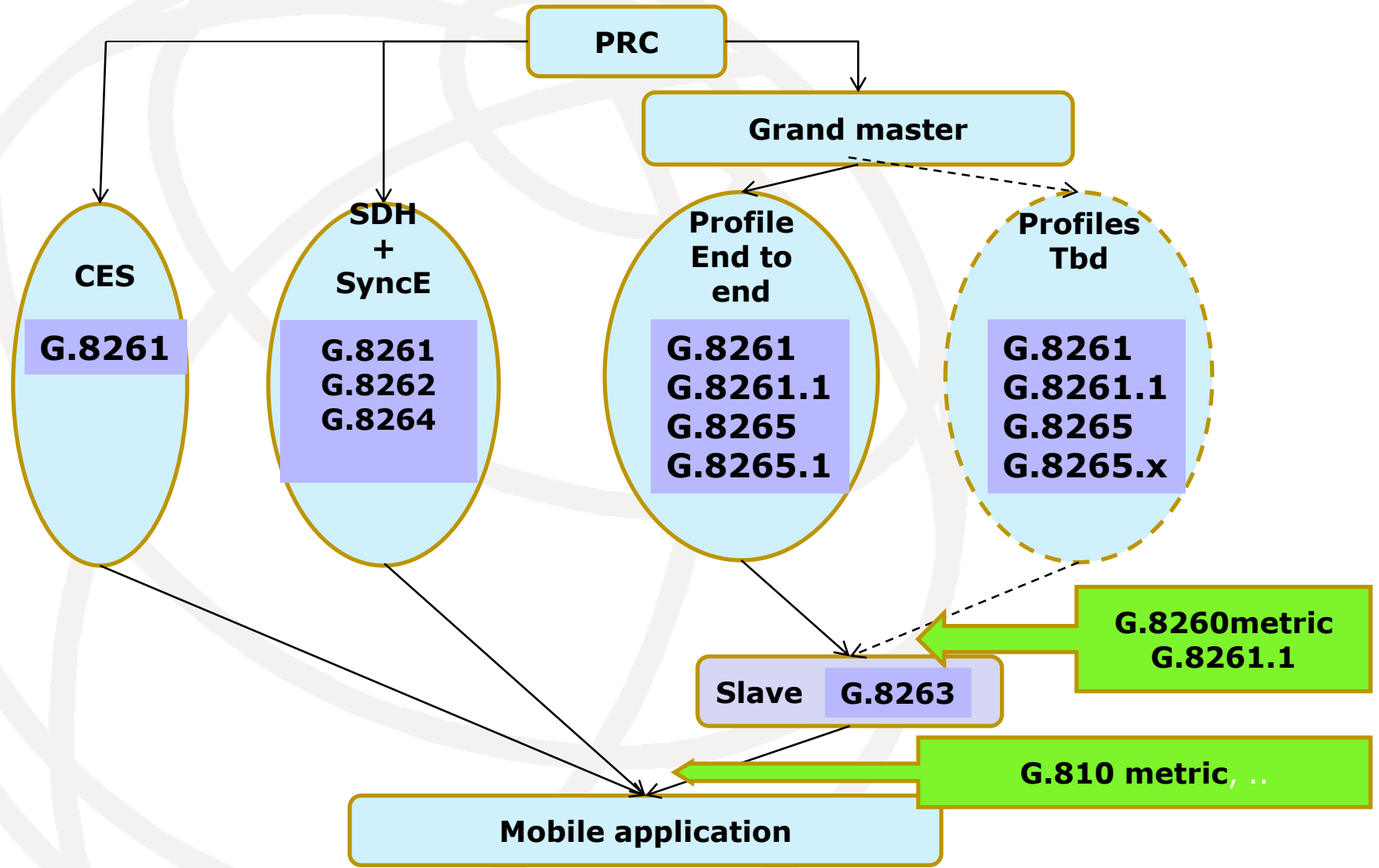

## 3- Transport of frequency in packet networks

- **All documents are now approved**
- **G.8260**
  - **Ongoing discussions on definitions and metrics**
- **G8261.1**
  - **Ongoing discussions on network limits**
- **Amendments on**
  - **G.8265**
    - IPV6 mapping added to IPV4**  
**(All equipments must support IPV4)**
  - **G.8262**
    - Considerations for measuring Noise Transfer for EEC-Option 2 clocks**

# 4-Transport of time and phase in packet networks

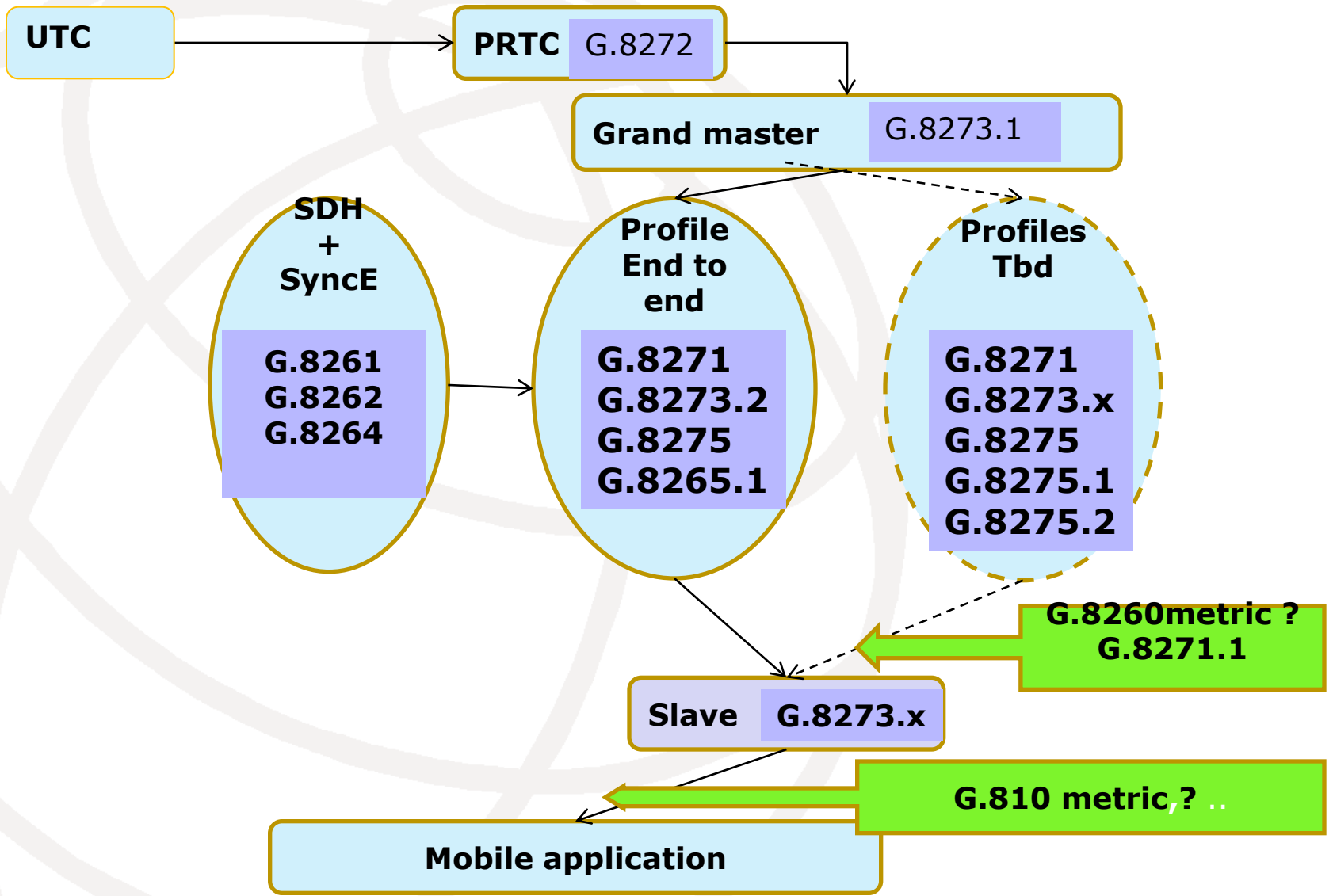



# **4.2 G.8271**

**It defines time and phase synchronization aspects in packet networks and the suitable methods to distribute the reference timing used to recover phase and time synchronization according to the required quality.**

**The main body deals with:**

- Need for phase and time**
- phase and time synchronization methods**
- Network reference model**

# 4.2-2 HRMs for network limits

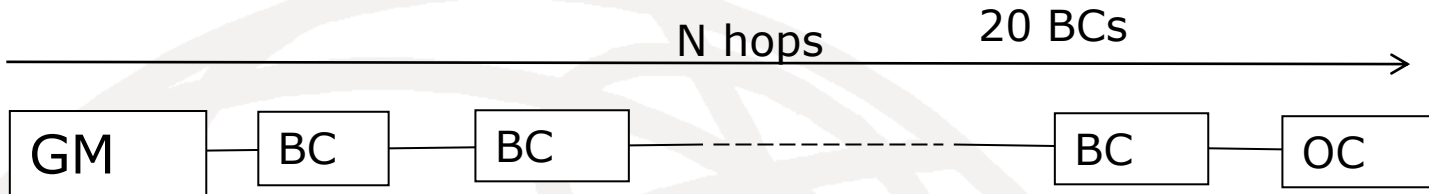

**HRM without frequency support**

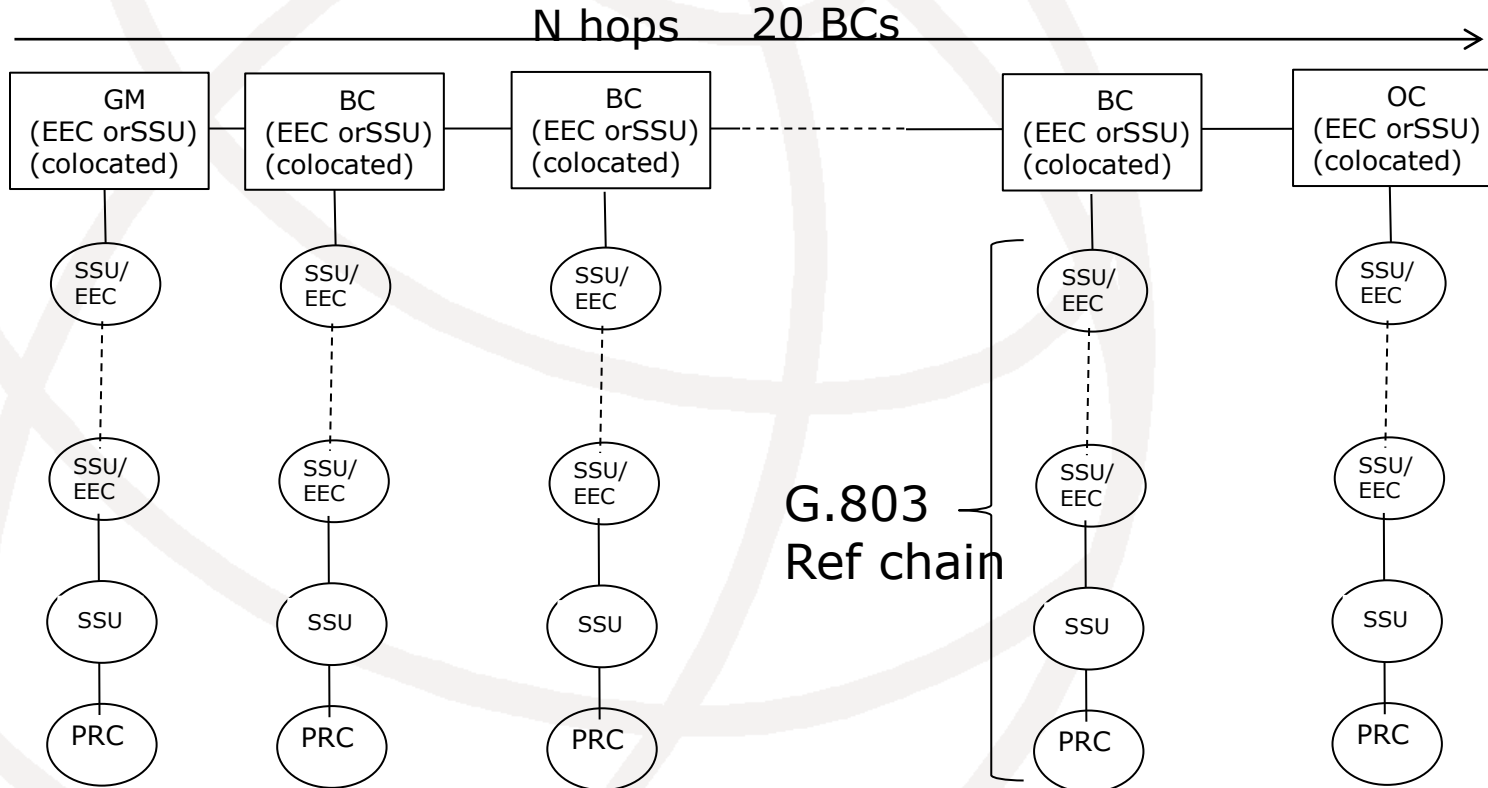

**HRM with frequency support**

# 4.3 G.8272 PRTC

## Primary reference time clock

### -Position of the PRTC in the network



**Note: functional representation,  
implementation might embed PRTC and Grand Master**

# 4.3 G.8272 PRTC

## -Functional model

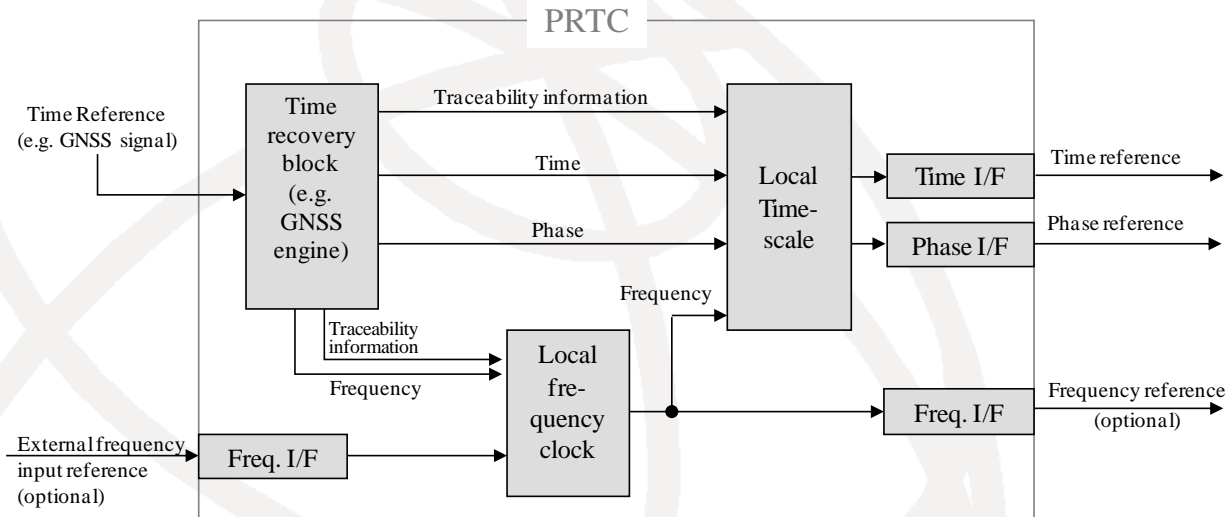

**Time recovery:** receives and processes the external time provides output signals to generate  $F$  ,  $\varphi$  and  $T$

**Local frequency clock:** generate the internal frequency , and might go in holdover or switch to an optional input frequency reference

**Local timescale :** maintains the local primary time scale

## 4.3 G.8272 PRTC

### -Noise definition

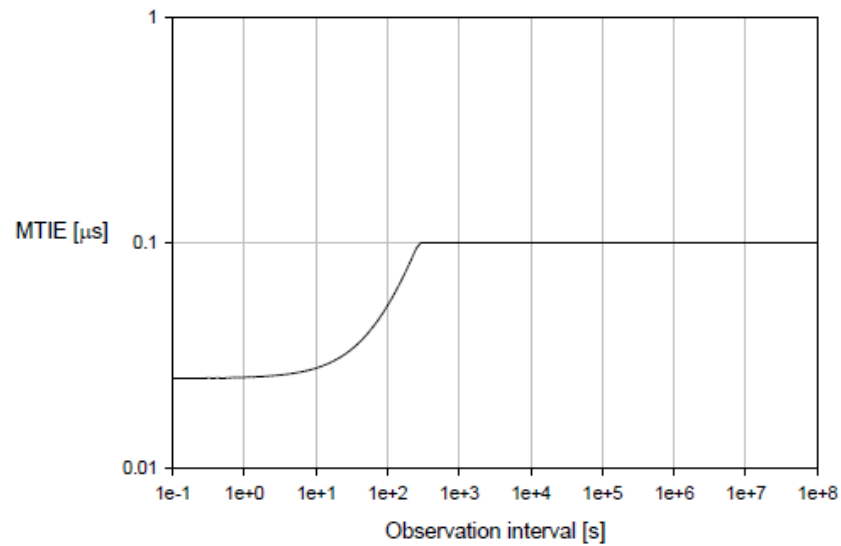

- Time holdover
- Not yet agreed

## 4.4 G.8273.3 Transparent clock

### IEEE 802.1Q "layer violation"

- A Transparent Clock, as defined in IEEE 1588, will modify the CorrectionField inside of a PTP header to record the residence time of the packet.
- Can we modify the content of a message without changing the MAC address? Are there other solutions?
- The question has been sent to IEEE 802.1Q

# G.8275.1

## PTP profile for the transport of T & $\varphi$

- **Need urgently a BC profile**
- **Priority given to a profile with T-BCs and frequency support from the network**
- **Progress**
- **Expected consent in July 2013**

# Evolution on time standard activity

- **In September several large US operators requested the start of a new profile with « partial on path support » based on application needs.**
- **Technical concerns were addressed on feasibility**
- **Agreement to study the technical issues first, then define the second profile G.8275.2**



# Preliminary to G.8275.2

**Current G.8271 defines:**

- **HRM without frequency support**
- **HRM with full frequency support**
- **A new HRM has to be defined for G.8275.2**
- **Does it impact the architecture in G.8275?**
- **Is this profile intended to match the same network limits as defined in G.8271.1?**
- **New simulations have to be performed**

## 4.5 G.Supp (1)

**Decision to create this supplement was taken to make available the technical work done for the definition of the transport of time over packet networks which could not be included in the recommendation due to its size.**

**Based on the 2 G.8271.1HRMs many simulations were performed to analyse clocks models and networks performance in order to define the architecture, equipment clock an network limits.**

**This work was done to provide the technical bases for the definition of G.8271.1, G.8275 and The G.8273 series.**

## 4.5 G.Supp (2)

**The current drafts already contains:**

- **EEC/SEC, SSU and PRC wander models**
  - **simulation of SyncE chains**
  - **Wander accumulation model for option 1 and option2 and initial results**
  - **Detailed simulation models of a T-BC**
- Existing material will be added dealing with**
- **SyncE rearrangements**
  - **analysis of protection scenarios**

# 6-synchronization standards in ITU SG15

	Circuits		Packets		
	TDM	OTN	SyncE	Frequency	Time
Definitions	<b>G.810</b>		<b>G.8260</b>		
Architecture	<b>G.803</b>	<b>G.8251</b>	<b>G.8261</b>	<b>G.8265</b>	<b>G.8275</b>
Performances		<b>G.8251</b>	<b>G.8261</b>	<b>G.8261.1</b>	<b>G.8271</b>
Functional models		<b>G.8251</b>	<b>G.8264</b> <b>G.781</b>	<b>G.8261</b>	<b>G.8271</b>
Profiles				<b>G.8265</b>	<b>G.8275.1</b> <b>G.8275.2</b>
Clock specifications		<b>G.8251</b>	<b>G.8262</b>	<b>G.8263</b>	<b>G.8273</b> <b>G.8273.x</b> <b>(x=1,2,3)</b>
Simulations					<b>G.SUPP</b>
Test equipments	<b>O.171</b> <b>O.172</b>	<b>O.173</b>	<b>O.174</b>		

# List of ITU-T main recommendations related to synchronization

- **G.803 (2000), *Architecture of transport networks based on the synchronous digital hierarchy (SDH)***
- **G.810 (1996), *Definitions and terminology for synchronization networks***
- **G.811 (1997), *Timing requirements of primary reference clocks***
- **G.812 (2004), *Timing requirements of slave clocks suitable for use as node clocks in synchronization networks***
- **G.813 (2003), *Timing requirements of SDH equipment slave clocks (SEC)***
- **G.822 (1988), *Controlled slip rate objectives on an international digital connection***
- **G.823 (2000), *The control of jitter and wander within digital networks which are based on the 2048 kbit/s hierarchy***
- **G.824 (2000), *The control of jitter and wander within digital networks which are based on the 1544 kbit/s hierarchy***
- **G.825 (2000), *The control of jitter and wander within digital networks which are based on the synchronous digital hierarchy (SDH )***
- **G.781 (1999), *Synchronization layer functions***

## Recommendations for timing over packet networks

- ***G.8260 (2010) Definitions and terminology for synchronization in packet networks***  
***(dec2011) Appendix1 on metrics***

## Recommendations for Synchronous Ethernet

- ***G.781 (2009), Synchronization layer functions***
- ***G.8261 (2008), Timing and Synchronization aspects in Packet Networks***
  - ***G.8261 Amd1 (2010)***
- ***G.8262 (2010), Timing characteristics of synchronous Ethernet Equipment slave clock (EEC)***
  - ***G.8262 Amd1 & 2 (2012)***
- ***G.8264 (2008), Distribution of timing through packet networks***
  - ▶ ***G.8264 Amd1 (2010)***
  - ▶ ***G.8264 Amd2 & Corr2 (Dec 2011)***

## Recommendations for OTN

- ***G.8251 (2010) The control of jitter and wander within the optical transport network (OTN)***
  - ***G.8251 Amd1 & 2 (2011) and Amd3 (2012)***
  - ***G.8251 Corr2 (Dec 2011)***

## **Recommendations for the telecom profile for frequency only**

- ***G.8261 (2008), Timing and Synchronization aspects in Packet Networks***
- ***G.8261.1 (Dec2011) Packet Delay Variation Network Limits applicable to Packet Based Methods (Frequency Synchronization)***
- ***G.8263 (Dec2011) Timing characteristics of packet based equipment clocks (PEC) and packet based service clocks (PSC)***
- ***G.8265 (2010) Architecture and requirements for packet based frequency delivery***
- ***G.8265.1 (2010) ITU-T profile for frequency distribution without timing support from the network (provisional title)***  
***G.8265.1 Amd1 (2011) & amd2 (2012)***

## **Recommendations for the telecom profile for time and phase**

***G.8271 (dec2011) Network requirements for transport of time/phase***

***G.8272 (Sept2012) Specification of Primary Reference Time Clock (PRTC)***

## **Future recommendations ( provisional titles)**

***G.8273 Specification of clocks for the transport of time/phase***

***G.8273.1 Telecom Grand Master***

***G.8273.2 Telecom boundary clock***

***G.8273.3 Telecom transparent clock (to be confirmed)***

***G.8275 Packet network architecture for the transport of time/phase***

***G.8275.1 Telecom profile for the transport of time/phase with full timing support from the network***

***G.8275.2 Telecom profile for the transport of time/phase with partial timing support from the network***



## Recommendation on Jitter and wander tests equipments

- **O.171 (1997)** *Timing jitter and wander measuring equipment for digital systems which are based on the plesiochronous digital hierarchy (PDH)*
- **O.172 (2005)** *Jitter and wander measuring equipment for digital systems which are based on the synchronous digital hierarchy (SDH)*
- **O.173 (2007)** *Jitter measuring equipment for digital systems which are based on the Optical Transport N...*
- **O.174 (2009)** *Jitter and wander measuring equipment for digital system  
based on synchronous Ethernet network*

# Where to get the recommendations?



<http://www.itu.int/ITU-T/recommendations/index.aspx?ser=G>



Calnex Solutions Ltd

[www.calnexsol.com](http://www.calnexsol.com)

Jean-loup Ferrant

Jean-loup.ferrant@calnexsol.com

Calnex Paragon Sync

